

Composite dry sliding bushings, metric dimensions

Principal dimensions			Basic load ratings		Mass	Designation
d	D	B	dynamic C	static C0		
mm			kN		kg	-
28	32	20	43	134	0,028	PCM 283220 E

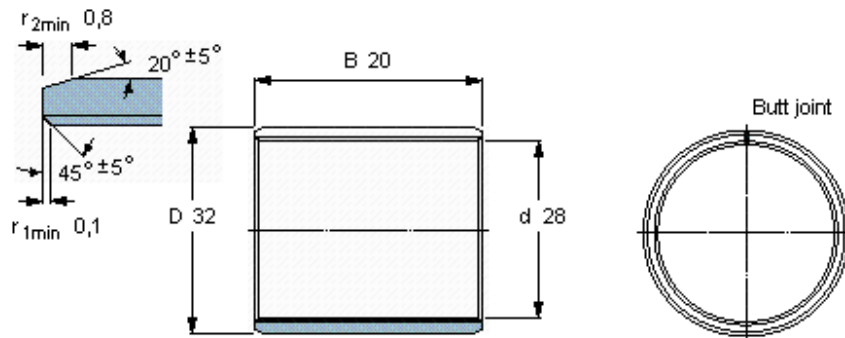

Specific load factor
Material constant

K 80
 K_M 480